

CHEMICAL ENGINEERING PREREQUISITE AND COREQUISITE COURSES (11.2024)

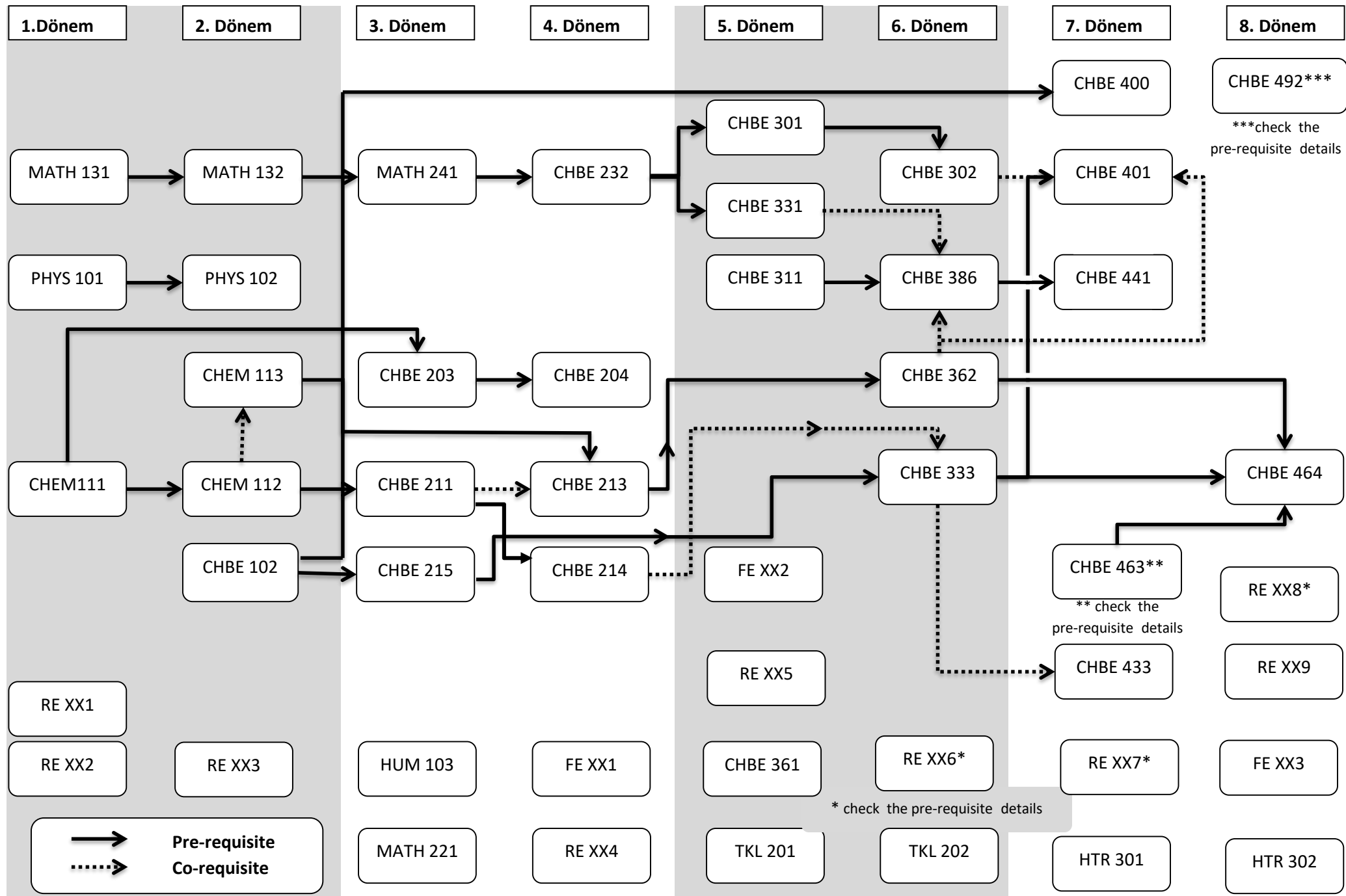

Prerequisite details:

* For students admitted in 2016 or later, at least three of the restricted elective courses must have CHBE code.

**** Students can register for CHBE 463 under following conditions:**

- i. A minimum of 80 credits (of 139 graduation credits) should be satisfied, and
- ii. In addition to (i), student should pass (with minimum DD grade) minimum two of the following courses:
 - a) CHBE 232 Fluid Dynamics
 - b) CHBE 331 Heat Transfer
 - c) CHBE 333 Mass Transfer
 - d) CHBE 362 Reactor Design

*** Students who are able to complete the curriculum by taking a maximum of 3 courses provided that the CHBE 400– Summer Internship course is also completed within the next semester can register for CHBE 492.